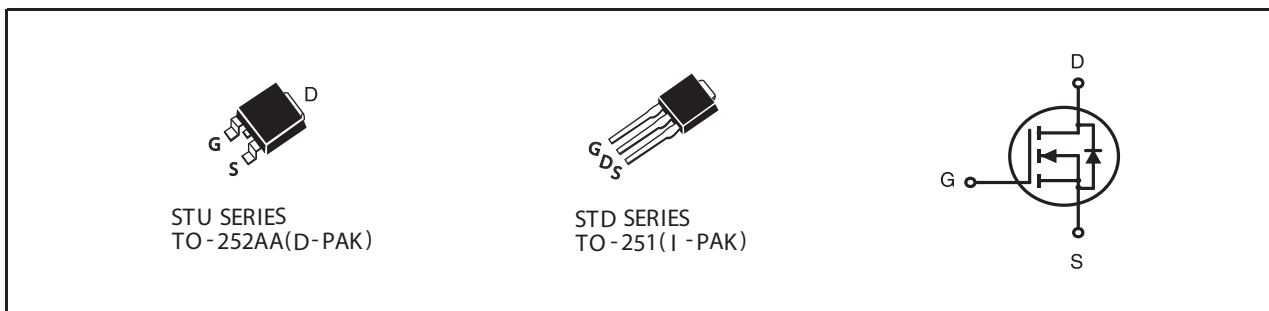

**N-Channel Logic Level Enhancement Mode Field Effect Transistor****PRODUCT SUMMARY**

VDSS	ID	RDS(ON) (mΩ) Typ
200V	8A	306 @ VGS=10V
		328 @ VGS=4.5V

FEATURES

- Super high dense cell design for low RDS(ON).
- Rugged and reliable.
- TO-252 and TO-251 Package.

**ABSOLUTE MAXIMUM RATINGS** ($T_C=25^\circ\text{C}$ unless otherwise noted)

Symbol	Parameter	Limit	Units
V_{DS}	Drain-Source Voltage	200	V
V_{GS}	Gate-Source Voltage	± 20	V
I_D	Drain Current-Continuous ^c	$T_C=25^\circ\text{C}$	8
		$T_C=70^\circ\text{C}$	6.4
I_{DM}	-Pulsed ^{a,c}	23	A
E_{AS}	Single Pulse Avalanche Energy ^d	16	mJ
P_D	Maximum Power Dissipation	$T_C=25^\circ\text{C}$	50
		$T_C=70^\circ\text{C}$	32
T_J, T_{STG}	Operating Junction and Storage Temperature Range	-55 to 150	$^\circ\text{C}$

THERMAL CHARACTERISTICS

$R_{\theta JC}$	Thermal Resistance, Junction-to-Case	2.5	$^\circ\text{C/W}$
$R_{\theta JA}$	Thermal Resistance, Junction-to-Ambient	50	$^\circ\text{C/W}$

STU10N20

STD10N20

Ver 1.0

ELECTRICAL CHARACTERISTICS (T_C=25°C unless otherwise noted)

Symbol	Parameter	Conditions	Min	Typ	Max	Units
OFF CHARACTERISTICS						
BV _{DSS}	Drain-Source Breakdown Voltage	V _{GS} =0V, I _D =10mA	200			V
I _{DSS}	Zero Gate Voltage Drain Current	V _{DS} =160V, V _{GS} =0V			1	μA
I _{GSS}	Gate-Body Leakage Current	V _{GS} = ±20V, V _{DS} =0V			±100	nA
ON CHARACTERISTICS						
V _{GS(th)}	Gate Threshold Voltage	V _{DS} =V _{GS} , I _D =250μA	1	2	3	V
R _{DS(ON)}	Drain-Source On-State Resistance	V _{GS} =10V, I _D =4A		306	370	m ohm
		V _{GS} =4.5V, I _D =3.9A		328	430	m ohm
g _{FS}	Forward Transconductance	V _{DS} =10V, I _D =4A		11		S
DYNAMIC CHARACTERISTICS^b						
C _{ISS}	Input Capacitance	V _{DS} =25V, V _{GS} =0V f=1.0MHz		1040		pF
C _{OSS}	Output Capacitance			63		pF
C _{RSS}	Reverse Transfer Capacitance			30		pF
SWITCHING CHARACTERISTICS^b						
t _{D(ON)}	Turn-On Delay Time	V _{DD} =100V I _D =1A V _{GS} =10V R _{GEN} = 6 ohm		20		ns
t _r	Rise Time			15.5		ns
t _{D(OFF)}	Turn-Off Delay Time			28		ns
t _f	Fall Time			10		ns
Q _g	Total Gate Charge		V _{DS} =100V, I _D =1A, V _{GS} =10V		15	
		V _{DS} =100V, I _D =1A, V _{GS} =4.5V		7.7		nC
Q _{gs}	Gate-Source Charge	V _{DS} =100V, I _D =1A, V _{GS} =10V		2.2		nC
Q _{gd}	Gate-Drain Charge			4		nC
DRAIN-SOURCE DIODE CHARACTERISTICS AND MAXIMUM RATINGS						
V _{SD}	Diode Forward Voltage	V _{GS} =0V, I _S =4A		0.81	1.3	V

Notes

- Pulse Test: Pulse Width ≤ 10μs, Duty Cycle ≤ 1%.
- Guaranteed by design, not subject to production testing.
- Drain current limited by maximum junction temperature.
- Starting T_J=25°C, L=0.5mH, V_{DD} = 50V. (See Figure 13)
- Mounted on FR4 Board of 1 inch², 2oz.

Aug, 14, 2014

STU10N20 STD10N20

Ver 1.0

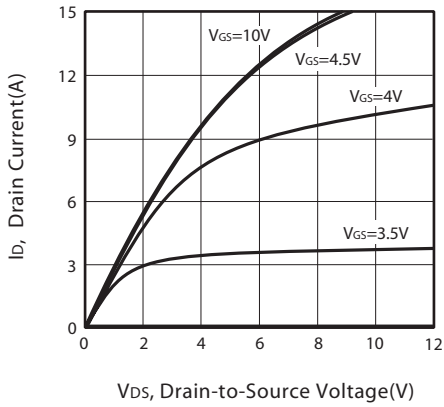

Figure 1. Output Characteristics

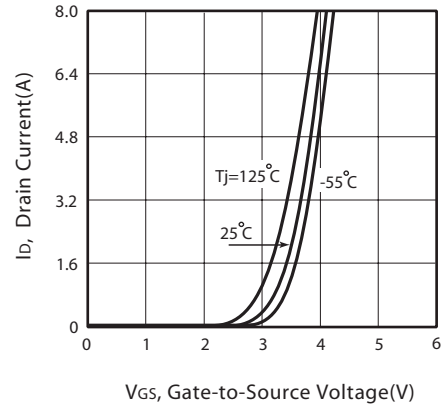

Figure 2. Transfer Characteristics

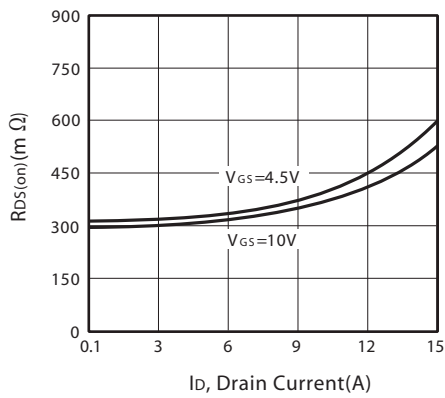

Figure 3. On-Resistance vs. Drain Current and Gate Voltage

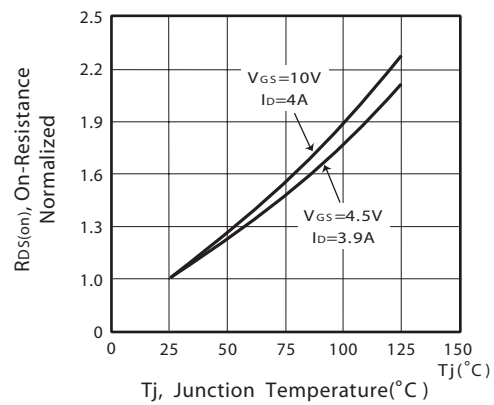

Figure 4. On-Resistance Variation with Drain Current and Temperature

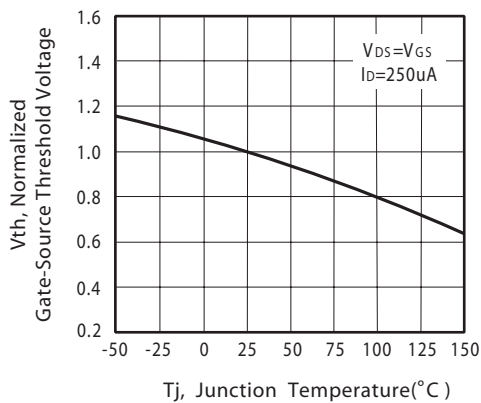

Figure 5. Gate Threshold Variation with Temperature

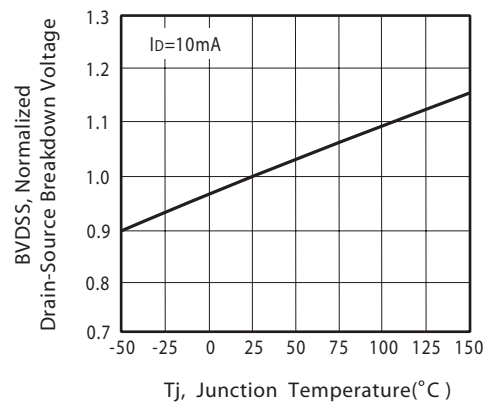

Figure 6. Breakdown Voltage Variation with Temperature

Aug, 14, 2014

STU10N20 STD10N20

Ver 1.0

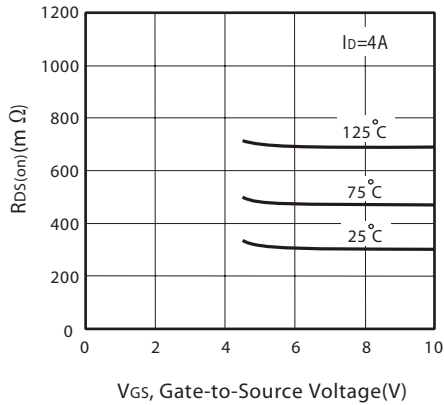

Figure 7. On-Resistance vs. Gate-Source Voltage

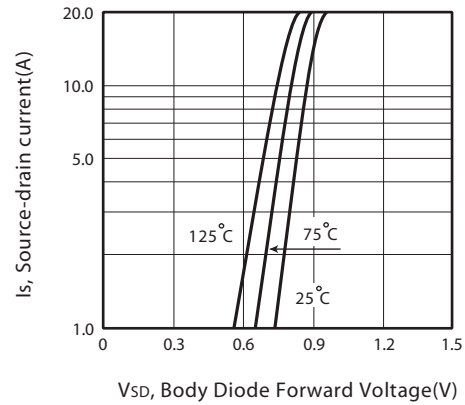

Figure 8. Body Diode Forward Voltage Variation with Source Current

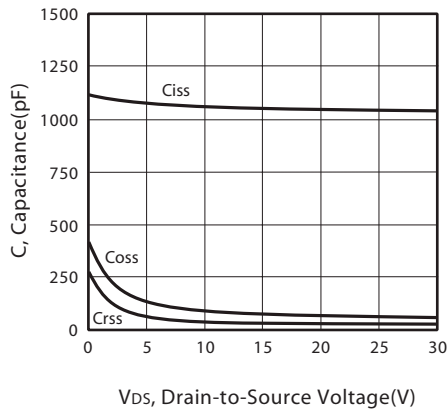

Figure 9. Capacitance

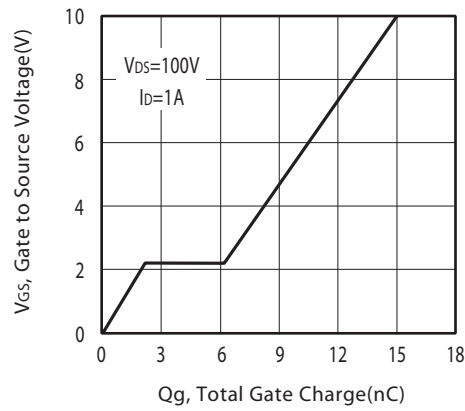

Figure 10. Gate Charge

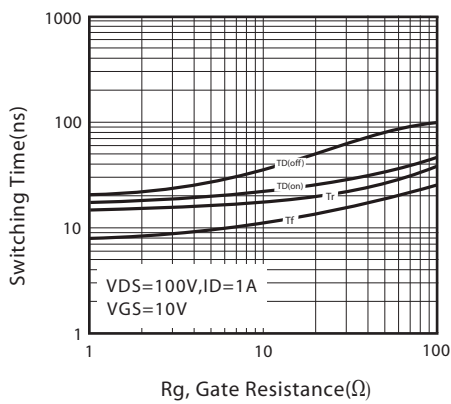

Figure 11. switching characteristics

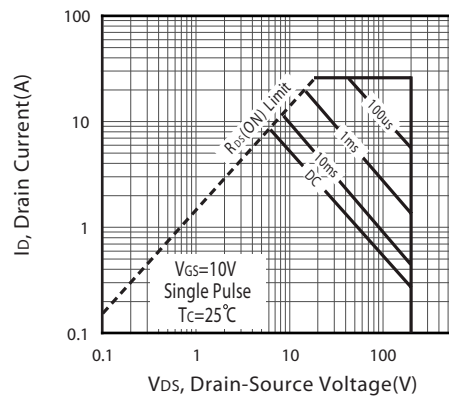
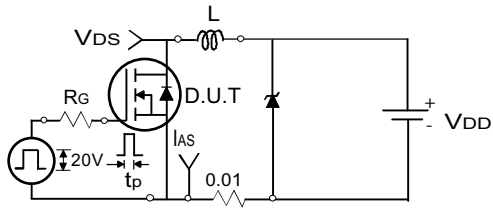

Figure 12. Maximum Safe Operating Area

Aug,14,2014

STU10N20 STD10N20



Uncamped Inductive Test Circuit

Figure 13a.

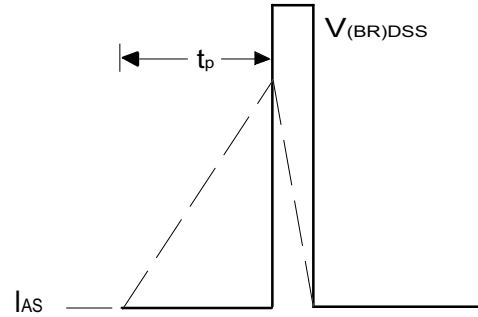

Unclamped Inductive Waveforms

Figure 13b.

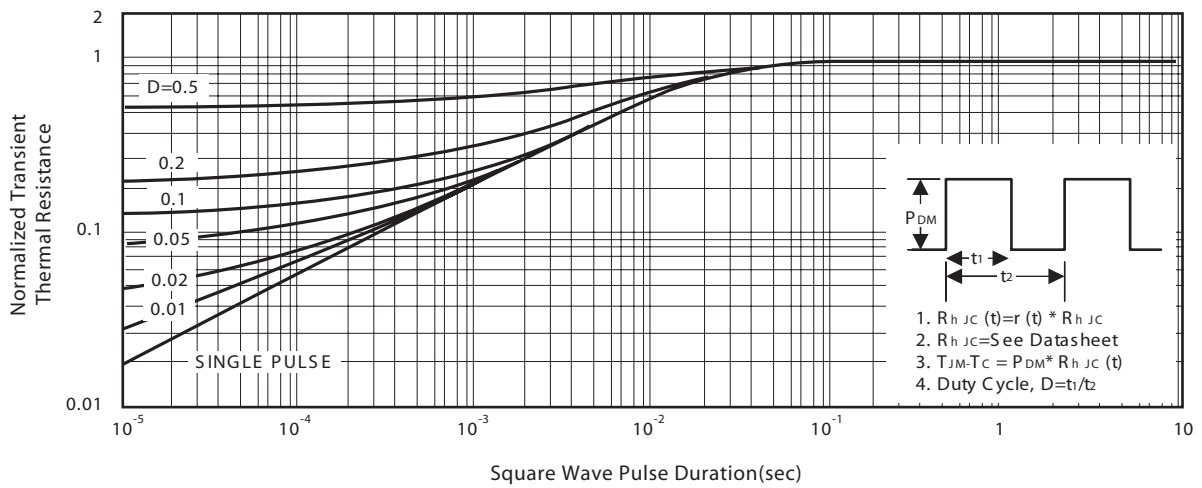
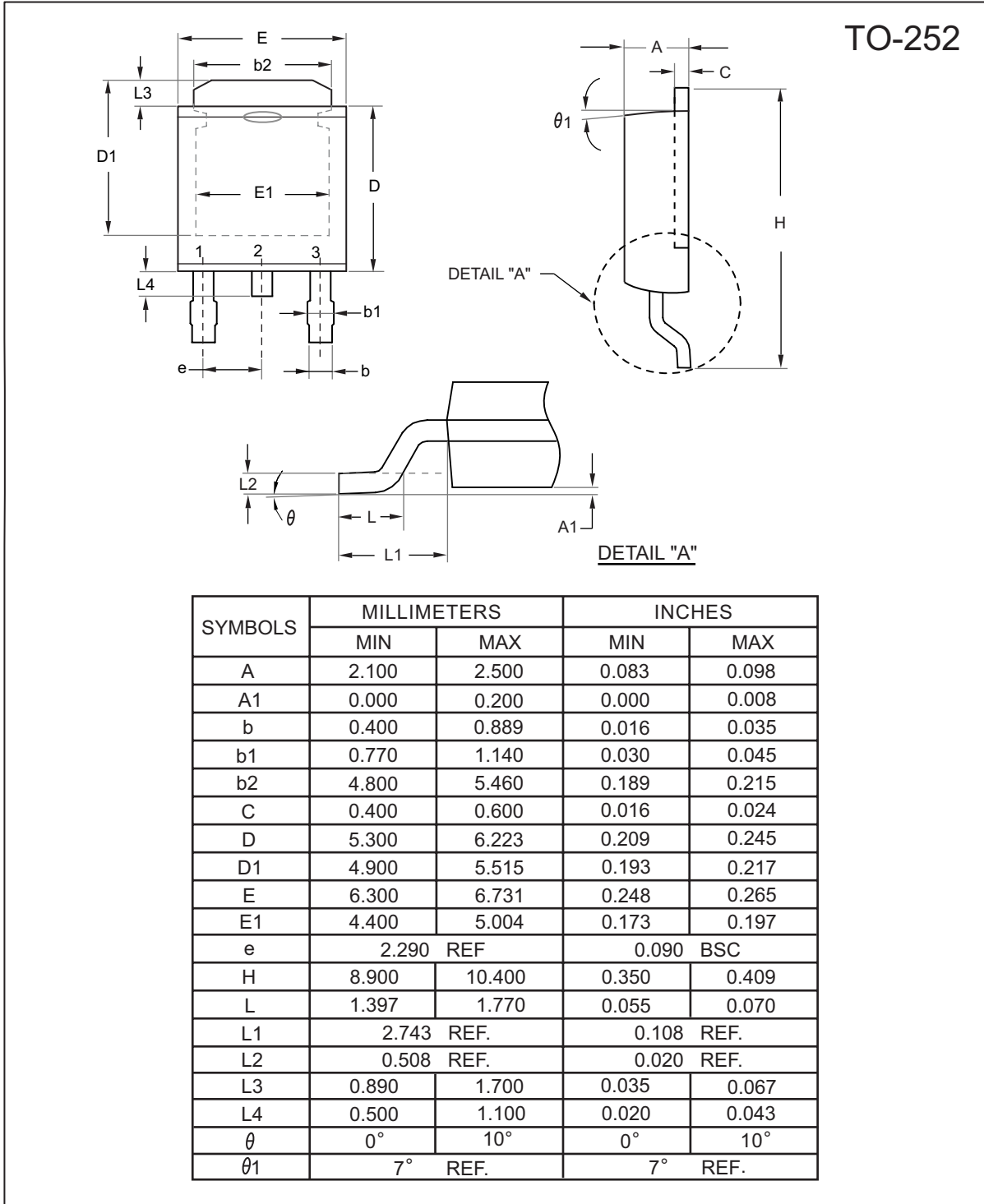

Figure 14. Normalized Thermal Transient Impedance Curve

STU10N20 STD10N20

Ver 1.0



Aug,14,2014

STU10N20

STD10N20

Ver 1.0

PACKAGE OUTLINE DIMENSIONS

TO-251

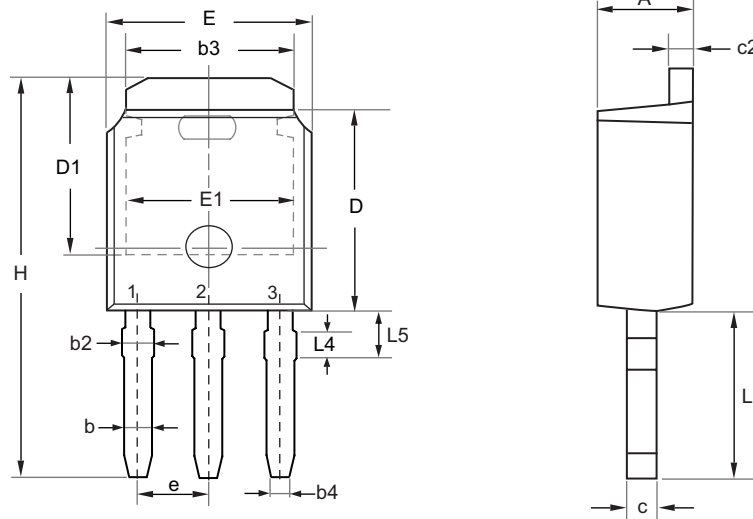

SYMBOL	MILLIMETERS		INCHES	
	MIN	MAX	MIN	MAX
E	6.400	6.731	0.252	0.265
L	3.980	4.280	0.157	0.169
L4	0.698 REF		0.027 REF	
L5	0.972	1.226	0.038	0.048
D	6.000	6.223	0.236	0.245
H	11.050	11.450	0.435	0.450
b	0.640	0.880	0.025	0.035
b2	0.770	1.140	0.030	0.045
b3	5.210	5.460	0.205	0.215
b4	0.450	0.550	0.018	0.022
e	2.286 BSC		0.090 BSC	
A	2.200	2.380	0.087	0.094
c	0.400	0.600	0.016	0.024
c2	0.400	0.600	0.016	0.024
D1	5.100	---	0.201	---
E1	4.400	---	0.173	---

Aug,14,2014

STU10N20 STD10N20

Ver 1.0

TO-251 Tube/TO-252 Tape and Reel Data

TO-251 Tube



TO-252 Carrier Tape

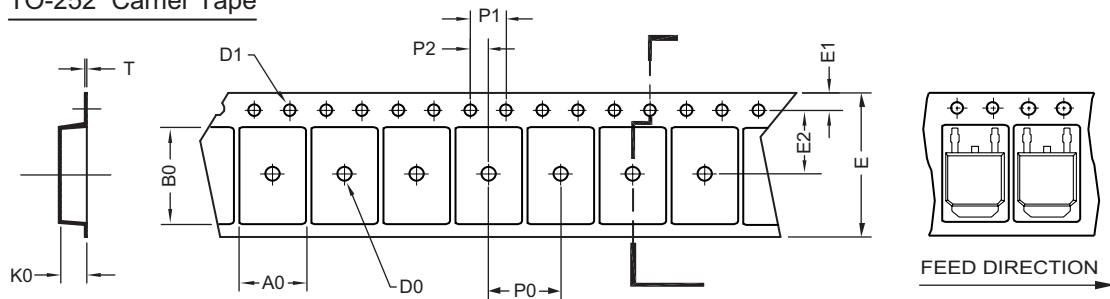

UNIT:mm

PACKAGE	A0	B0	K0	D0	D1	E	E1	E2	P0	P1	P2	T
TO-252 (16 mm)	6.96 ±0.1	10.49 ±0.1	2.79 ±0.1	φ 2	φ 1.5 + 0.1 - 0	16.0 ±0.3	1.75 ±0.1	7.5 ±0.15	8.0 ±0.1	4.0 ±0.1	2.0 ±0.15	0.3 ±0.05

TO-252 Reel

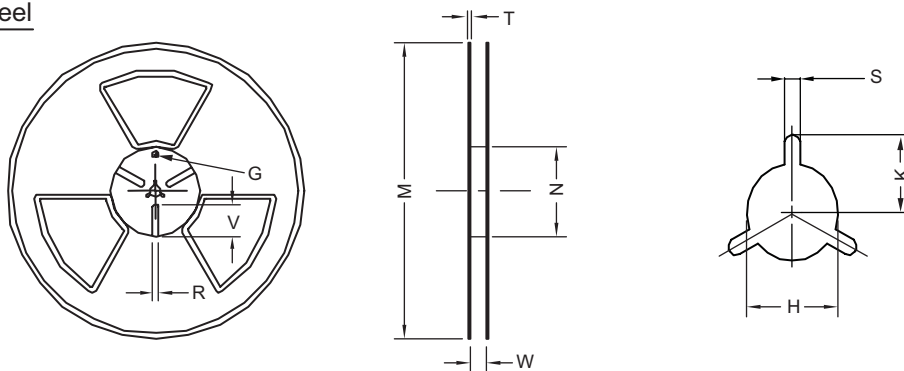

UNIT:mm

TAPE SIZE	REEL SIZE	M	N	W	T	H	K	S	G	R	V
16 mm	φ 330	φ 330 ± 0.5	φ 97 ± 1.0	17.0 + 1.5 - 0	2.2	φ 13.0 + 0.5 - 0.2	10.6	2.0 ±0.5	---	---	---

Aug,14,2014

STU10N20 STD10N20

Ver 1.0

TOP MARKING DEFINITION

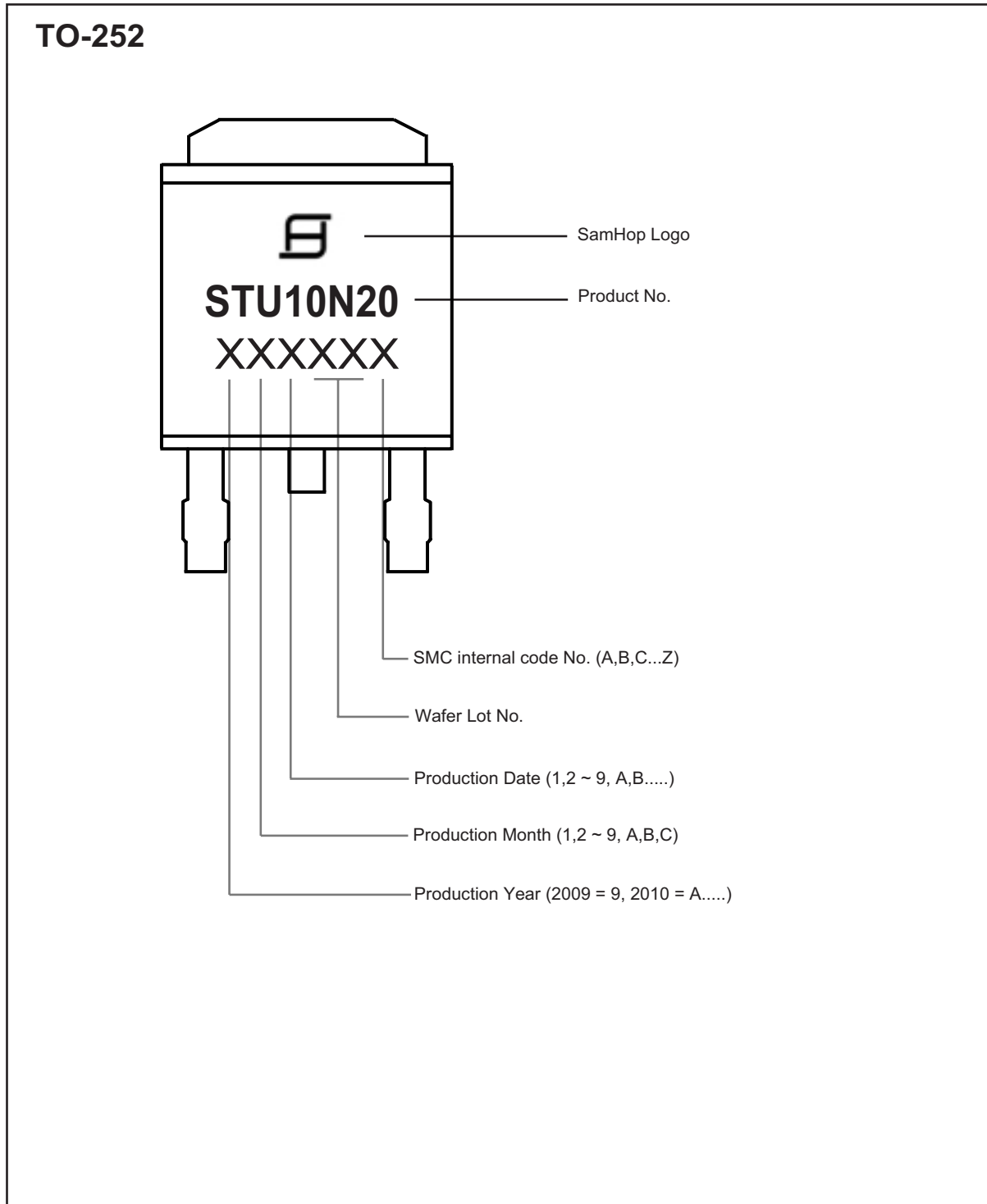

Aug,14,2014

STU10N20 STD10N20

TOP MARKING DEFINITION

